

Lantern Range

ASD has combined the skill and expertise gained from 25 years experience in the lighting industry to design a range of lighting suitable for all outdoor applications. Using the latest manufacturing techniques we have produced a superb range of lanterns, all our products conform to the latest british (BS EN 60 598-2-1) and European safety standards. All photocell and PIR modules carry a 3 year guarantee.

The lanterns are available in a wide range of colour options including Black, White, Verdi, Antique, Terracotta and Stone.

Lanterns are available with photocell and P.I.R for convenience and security.

- Easy to install.
- IP44.
- Anti-Vandal polycarbonate.
- Quick fit bracket available on wall mounted coach, globe and new four sided lantern.
- Corner Bracket.
- Energy saving lamp options.
- Choice of standard, photocell and P.I.R options.

PI.R: Day time walk test.
Shatter-proof Polycarbonate detector.
PI.R Range of 6 Metres.
110° Angle of detection.

- Photocell: Dusk to dawn sensor.
Switches on at dusk and off at dawn.
- Designed to BS EN 60598-2-1.

PIR

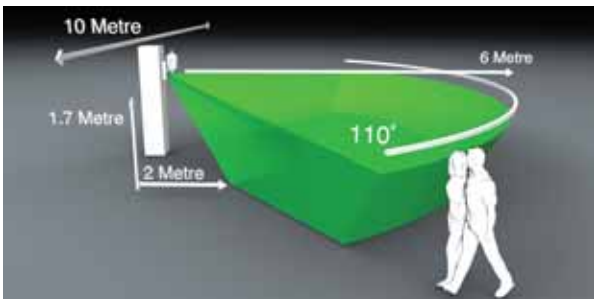

Quick Fit - Coach, Globe and Four Sided lanterns

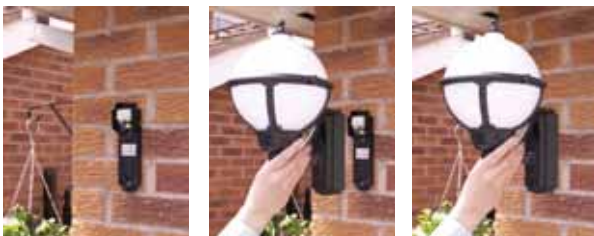

Anti Vandal

Shatterproof Polycarbonate construction is tough, hardwearing and helps prevent damage from vandals; making it a safe alternative to glass covered units. Polycarbonate is weather resistant and UV stable. The solid black or white finished units won't suffer from paint peel or deteriorate through weathering, the anti corrosion properties are ideal for sea front locations.



P.I.R.

Providing proximity detection and security, allowing operation by movement and presence of intruders or visitors. The P.I.R units have a pre-set time of 2 to 3 minutes and can be switched to permanent lighting.



3 Year Photocell and P.I.R. Guarantee

Both Photocell and PIR are protected within sealed modules and as such we are confident of the highest quality operation, providing you with the confidence in your installation of ASD product.



Quick Fit

This unique fast fit electrical connection features on the Globe and Coach wall mounted models. It eases installation, is quick, safe and helps prevent the end user installing the product incorrectly.



Photocell

The dusk to dawn sensor is factory set to activate the light as soon as darkness falls and turns off the light during day light hours, enhancing the security of your home (these units are for external use only).



Corner Bracket

Optional corner bracket to provide versatility of installation.

Manufactured from polycarbonate the bracket can be used with both the Coach and Globe wall mounted lanterns and allows users to benefit from the ASD Unique Quick Fit connector. Each bracket is supplied with wall plugs and fixing screws.



Weather Proof

The lantern ranges polycarbonate construction not only provides a tough vandal resistant fitting but the UV stable polycarbonate offers exceptional weathering benefits over die cast aluminium units. Polycarbonate won't suffer from paint peel or chipping making the range ideal for coastal locations.

Government tariffs on energy now require genuine savings to be made. ASD's lanterns offer a comprehensive range of energy saving lamp options to meet L1 building regulation requirements.

Coach Lantern

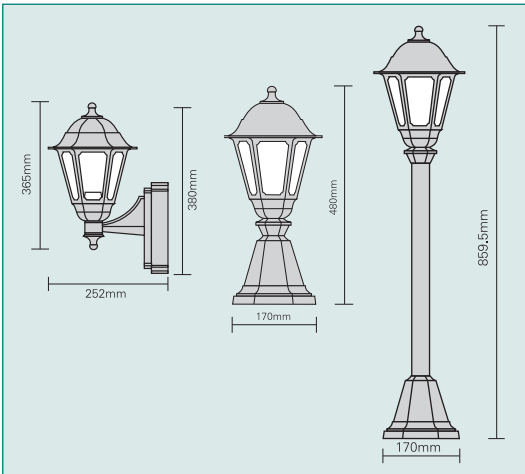

Traditional, elegant design manufactured in vandal resistant polycarbonate with all the anti weathering benefits over die cast aluminium.

The wall mounted units benefit from the versatile QUICK FIT system, the unique fast fit electrical connection eases installation and helps prevent the end user installing the product incorrectly.

The lantern range is available as standard for use with 100w lamps or energy saving 9w lamps which provide a longer life and save up to 80% energy compared to a standard light bulb.



Wall Mounted Coach



Colour	Standard 100w	PI.R 110°	Photocell Lantern	9W Lantern	9W Photocell	13W HF Lantern	13W HF PC Lantern	18W HF Lantern	18W HF PC Lantern	Patio 100w	Mini Column 100w
● Black	CL/BK100	CL/BK100P	CL/BK100C	CL/BK009	CL/BK009C	CL/BK113E	CL/BK113EC	CL/BK118E	CL/BK118EC	CP/BK100	MC/BK100
○ White	CL/WK100	CL/WK100P	CL/WK100C	CL/WK009	CL/WK009C	CL/WK113E	CL/WK113EC	CL/WK118E	CL/WK118EC	CP/WK100	MC/WK100
● Verdi	CL/VK100	CL/VK100P	CL/VK100C	CL/VK009	CL/VK009C	CL/VK113E	CL/VK113EC	CL/VK118E	CL/VK118EC	CP/VK100	MC/VK100
● Antique	CL/QK100	CL/QK100P	CL/QK100C	CL/QK009	CL/QK009C	CL/QK113E	CL/QK113EC	CL/QK118E	CL/QK118EC	CP/QK100	MC/QK100
● Terracotta	CL/TK100	CL/TK100P	CL/TK100C	CL/TK009	CL/TK009C	CL/TK113E	CL/TK113EC	CL/TK118E	CL/TK118EC	CP/TK100	MC/TK100
● Stone	CL/SK100	CL/SK100P	CL/SK100C	CL/SK009	CL/SK009C	CL/SK113E	CL/SK113EC	CL/SK118E	CL/SK118EC	CP/SK100	MC/SK100



Patio Lantern



Mini Column

Corner Bracket

Colour	Code
● Black	CLB/B
○ White	CLB/W

Lanterns are purchased separately

Terracotta and stone finished items are subject to minimum order quantities. Please contact our sales department for further details.

Quick Fit



Lantern Range

Globe Lantern

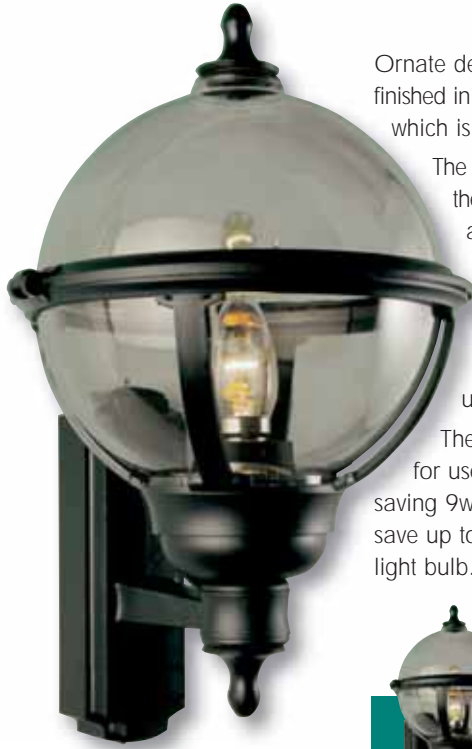

Wall Mounted Globe



Patio Globe



Mini Column Globe

Ornate design with Classical Globe diffuser, finished in either Smoke or Opal polycarbonate, which is vandal and weather resistant.

The lantern design optimises light distribution, the Globe Lantern Diffuser hinges for easy access.

The wall mounted units benefit from the versatile QUICK FIT system, the unique fast fit electrical connection eases installation and helps prevent the end user installing the product incorrectly.

The lantern range is available as standard for use with 100w GLS lamps or with energy saving 9w lamps which provide a longer life and save up to 80% energy compared to a standard light bulb.

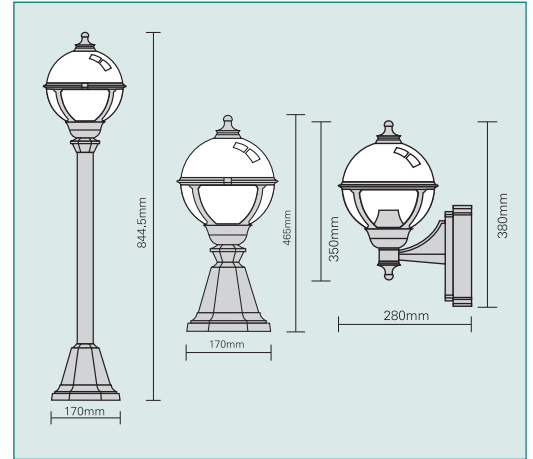

	Standard 100W	PI.R 110*	Photocell Lantern	9W Lantern	9W Photocell	13W HF Lantern	13W HF PC Lantern	18W HF Lantern	18W HF PC Lantern	Patio 100W	Mini Column 100W
● Black	GL/BS100	GL/BS100P	GL/BS100C	GL/BS009	GL/BS009C	GL/BS113E	GL/BS113EC	GL/BS118E	GL/BS118EC	PG/BS100	MG/BS100
○ White	GL/WS100	GL/WS100P	GL/WS100C	GL/WS009	GL/WS009C	GL/WS113E	GL/WS113EC	GL/WS118E	GL/WS118EC	PG/WS100	MG/WS100
● Verdi	GL/VS100	GL/VS100P	GL/VS100C	GL/VS009	GL/VS009C	GL/VS113E	GL/VS113EC	GL/VS118E	GL/VS118EC	PG/VS100	MG/VS100
● Antique	GL/OS100	GL/OS100P	GL/OS100C	GL/OS009	GL/OS009C	GL/OS113E	GL/OS113EC	GL/OS118E	GL/OS118EC	PG/OS100	MG/OS100
● Terracotta	GL/TS100	GL/TS100P	GL/TS100C	GL/TS009	GL/TS009C	GL/TS113E	GL/TS113EC	GL/TS118E	GL/TS118EC	PG/TS100	MG/TS100
● Stone	GL/SS100	GL/SS100P	GL/SS100C	GL/SS009	GL/SS009C	GL/SS113E	GL/SS113EC	GL/SS118E	GL/SS118EC	PG/SS100	MG/SS100

Opal											
● Black	GL/BL100	GL/BL100P	GL/BL100C	GL/BL009	GL/BL009C	GL/BL113E	GL/BL113EC	GL/BL118E	GL/BL118EC	PG/BL100	MG/BL100
○ White	GL/WL100	GL/WL100P	GL/WL100C	GL/WL009	GL/WL009C	GL/WL113E	GL/WL113EC	GL/WL118E	GL/WL118EC	PG/WL100	MG/WL100
● Verdi	GL/ML100	GL/ML100P	GL/ML100C	GL/ML009	GL/ML009C	GL/ML113E	GL/ML113EC	GL/ML118E	GL/ML118EC	PG/ML100	MG/ML100
● Antique	GL/QL100	GL/QL100P	GL/QL100C	GL/QL009	GL/QL009C	GL/QL113E	GL/QL113EC	GL/QL118E	GL/QL118EC	PG/QL100	MG/QL100
● Terracotta	GL/TL100	GL/TL100P	GL/TL100C	GL/TL009	GL/TL009C	GL/TL113E	GL/TL113EC	GL/TL118E	GL/TL118EC	PG/TL100	MG/TL100
● Stone	GL/SL100	GL/SL100P	GL/SL100C	GL/SL009	GL/SL009C	GL/SL113E	GL/SL113EC	GL/SL118E	GL/SL118EC	PG/SL100	MG/SL100

Terracotta and stone finished items are subject to minimum order quantities. Please contact our sales department for further details.

Corner Bracket

Colour	Code
● Black	CLB/B
○ White	CLB/W

Lanterns are purchased separately

Quick Fit





Half Lantern

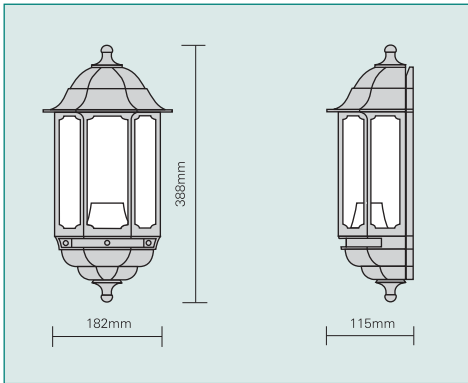

Classic design Half Lantern in Polycarbonate which is vandal and weather resistant.

The Lantern is designed to be fitted near to doorways to optimise illumination for entrance areas, with this location in mind the P.I.R operates at 6 metres to reduce the number of nuisance activations.

The Lantern range is available as standard for use with 60w GLS lamps or with energy saving 9w lamps which provide a longer life and save up to 80% energy compared to a standard light bulb.



Colour	Standard 60w	P.I.R 110°	Photocell Lantern	9W Lantern	9W Photocell	13W HF Lantern	13W HF PC Lantern	18W HF Lantern	18W HF PC Lantern
● Black	HL/BK060	HL/BK060P	HL/BK060C	HL/BK009	HL/BK009C	HL/BK113E	HL/BK113EC	HL/BK118E	HL/BK118EC
○ White	HL/WK060	HL/WK060P	HL/WK060C	HL/WK009	HL/WK009C	HL/WK113E	HL/WK113EC	HL/WK118E	HL/WK118EC
● Verdi	HL/VK060	HL/VK060P	HL/VK060C	HL/VK009	HL/VK009C	HL/VK113E	HL/VK113EC	HL/VK118E	HL/VK118EC
● Antique	HL/QK060	HL/QK060P	HL/QK060C	HL/QK009	HL/QK009C	HL/QK113E	HL/QK113EC	HL/QK118E	HL/QK118EC
● Terracotta	HL/TK060	HL/TK060P	HL/TK060C	HL/TK009	HL/TK009C	HL/TK113E	HL/TK113EC	HL/TK118E	HL/TK118EC
● Stone	HL/SK060	HL/SK060P	HL/SK060C	HL/SK009	HL/SK009C	HL/SK113E	HL/SK113EC	HL/SK118E	HL/SK118EC

Terracotta and stone finished items are subject to minimum order quantities. Please contact our sales department for further details.

Lantern Range

Grande Lantern



Georgian

The Grande Lantern offers up to 150W GLS and a comprehensive range of low energy Compact Fluorescent lamp variants, allowing compliance with L1 building requirements for the provision of energy saving lighting.

Elegantly designed with rustic mounting arm and bevelled polycarbonate lens the range is not only attractive but extremely robust. The vandal resistant polycarbonate casing is available in black or white; the UV stable "colour fast" polycarbonate won't suffer from chipping or paint peel. A hand brushed Verdi finish is also available.

- Easy to install.
- IP44.
- Anti-Vandal polycarbonate.
- Energy saving lamp options.
- Choice of standard or photocell options.
- Designed to BS EN 60598-2-1.

Energy Saving Lamp Comparisons

Energy Saving Option	Total Circuit Wattage	Lumen Output	GLS Equivalent
18w (HF Circuit) TC-DE	19w	1200	100w
26w (HF Circuit) TC-DE	27w	1710	150w
32w (HF Circuit) TC-TE	33w	2200	200w

Average rated life = 10,000 hours



Victorian

Colour	Grande Victorian Lantern				Lantern PC			
	150W Lantern	18W HF Lantern	26W HF Lantern	32W HF Lantern	150W + PC Lantern	18W HF + PC Lantern	26W HF + PC Lantern	32W HF + PC Lantern
● Black	GCU/BK150	GCU/BK118E	GCU/BK126E	GCU/BK132E	GCU/BK150C	GCU/BK118EC	GCU/BK126EC	GCU/BK132EC
○ White	GCU/WK150	GCU/WK118E	GCU/WK126E	GCU/WK132E	GCU/WK150C	GCU/WK118EC	GCU/WK126EC	GCU/WK132EC
● Verdi	GCU/VK150	GCU/VK118E	GCU/VK126E	GCU/VK132E	GCU/VK150C	GCU/VK118EC	GCU/VK126EC	GCU/VK132EC

Colour	Grande Georgian Lantern				Lantern PC			
	150W Lantern	18W HF Lantern	26W HF Lantern	32W HF Lantern	150W + PC Lantern	18W HF + PC Lantern	26W HF + PC Lantern	32W HF + PC Lantern
● Black	GCD/BK150	GCD/BK118E	GCD/BK126E	GCD/BK132E	GCD/BK150C	GCD/BK118EC	GCD/BK126EC	GCD/BK132EC
● White	GCD/WK150	GCD/WK118E	GCD/WK126E	GCD/WK132E	GCD/WK150C	GCD/WK118EC	GCD/WK126EC	GCD/WK132EC
○ Verdi	GCD/VK150	GCD/VK118E	GCD/VK126E	GCD/VK132E	GCD/VK150C	GCD/VK118EC	GCD/VK126EC	GCD/VK132EC



Patio Lantern

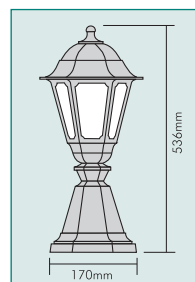
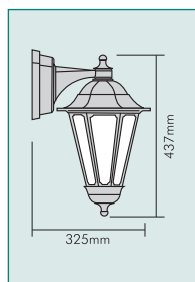
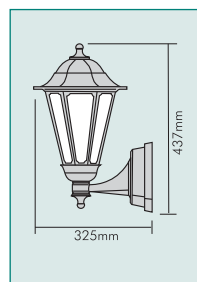

Patio Lantern

Colour	150W Lantern
● Black	GCP/BK150
○ White	GCP/WK150



Black PIR

Providing convenience, security and courtesy lighting solutions in a range of attractive, easy to install, practical and hardwearing luminaires.

The range meets the demands of domestic and commercial installations with robust casing and extremely effective, flexible and reliable PIR and photocell options for convenience and security.

- Low energy PIR14 option (75W GLS Equivalent).
- Easy to install.
- IP44.
- Anti-Vandal polycarbonate.
- Quick fit bracket available on wall mounted lantern.
- Corner Bracket.
- Energy saving lamp options.
- Choice of standard, photocell and P.I.R options.
- Designed to BS EN 60598-2-1.

Square Lantern



White

Corner Bracket

Colour	Code
● Black	CLB/B
○ White	CLB/W

Lanterns are purchased separately

Quick Fit



Colour	Standard 100w	PI.R 110°	Photocell Lantern	9W Lantern	9W Photocell	13W HF Lantern	13W HF PC Lantern	18W HF Lantern	18W HF PC Lantern
● Black	CL4/BK100	CL4/BK100P	CL4/BK100C	CL4/BK009	CL4/BK009C	CL4/BK113E	CL4/BK113EC	CL4/BK118E	CL4/BK118EC
○ White	CL4/WK100	CL4/WK100P	CL4/WK100C	CL4/WK009	CL4/WK009C	CL4/WK113E	CL4/WK113EC	CL4/WK118E	CL4/WK118EC
● Verdi	CL4/VK100	CL4/VK100P	CL4/VK100C	CL4/VK009	CL4/VK009C	CL4/VK113E	CL4/VK113EC	CL4/VK118E	CL4/VK118EC
● Antique	CL4/QK100	CL4/QK100P	CL4/QK100C	CL4/QK009	CL4/QK009C	CL4/QK113E	CL4/QK113EC	CL4/QK118E	CL4/QK118EC
● Terracotta	CL4/TK100	CL4/TK100P	CL4/TK100C	CL4/TK009	CL4/TK009C	CL4/TK113E	CL4/TK113EC	CL4/TK118E	CL4/TK118EC
● Stone	CL4/SK100	CL4/SK100P	CL4/SK100C	CL4/SK009	CL4/SK009C	CL4/SK113E	CL4/SK113EC	CL4/SK118E	CL4/SK118EC

